



CHESHIRE
mouldings

Love the home you're in

DECKING
BALUSTRADES
2013/



GIVE YOUR SUMMER A UNIQUE FINISHING TOUCH WITH OUR STUNNING BALUSTRADES/

Cheshire Mouldings is the UK's leading manufacturer of outdoor balustrade components because we go further to give you the best possible finish, turning decking into a sensational seasonal living experience that lasts year after year. Only the finest quality timbers make it into our products, all from sustainable sources, and designed to give your decking a unique quality finish you'll be proud of now and for years to come.

CORE TURNED & CONTEMPORARY

We have the perfect solution for every style of decking. Whether you're looking for understated elegance or contemporary flair we have a portfolio that will compliment your environment and personal taste. From our **Core DEK** range, with traditional turned and stop chamfered designs bringing classical elegance to any decking feature, to our **Axxys DEK**, **Metal DEK**, **Clear DEK** and **Modern DEK** which are at the cutting edge of outdoor balustrade design with their use of toughened glass and cast metal details.

QUALITY THAT LASTS

At Cheshire Mouldings we take pride in the quality of our decking components, because we understand how important they are in creating the right finish and how that finish needs to be sustainable, year after year. That's why all our softwood balustrades come pre-treated with TANALITH E preservative to help protect your deck from the inside out. Other than pressure washing and resealing once or twice a season, all you have to do with your deck is literally sit back and enjoy it.

DECKING DONE THE RIGHT WAY

As members of the Timber Decking Association we understand just how important good design and use of the best materials is. Above all we understand that a good deck is a safe deck, which is why our systems are tested to BSBS6180:1999. Decks can also be substantial features in their own right and so our advice to homeowners and contractors alike is to always check with your local planning authority before you start your project.

Look for FSC® certified products



The mark of responsible forestry



CORE DEK STOP CHAMFERED
SOFTWOOD/04

CORE DEK STOP CHAMFERED
RED HARDWOOD/06

CORE DEK TURNED
SOFTWOOD/08

CORE DEK TURNED
RED HARDWOOD/10

CORE DEK AMERICAN
SOFTWOOD/12

CORE DEK SQUARED
SOFTWOOD/14

axxys® DEK STOP CHAMFERED
SOFTWOOD/16

axxys® DEK STOP CHAMFERED
RED HARDWOOD/18

axxys® DEK FRETTED SQUARE
SOFTWOOD/20

METAL DEK BOW & EDEN
ALUMINIUM/22

CLEAR DEK CLEAR
SOFTWOOD/24

MODERN DEK
ZINC/26

COMPONENTS/28

Whilst every care has been taken to ensure the accuracy of this brochure, we cannot accept responsibility for the colour representation of our wood products due to the restrictions of the printing process.



CORE DEK

STOP CHAMFERED SOFTWOOD/

The solidity of our stop chamfered range can take everything nature can throw at it and still look great as the sun goes down.

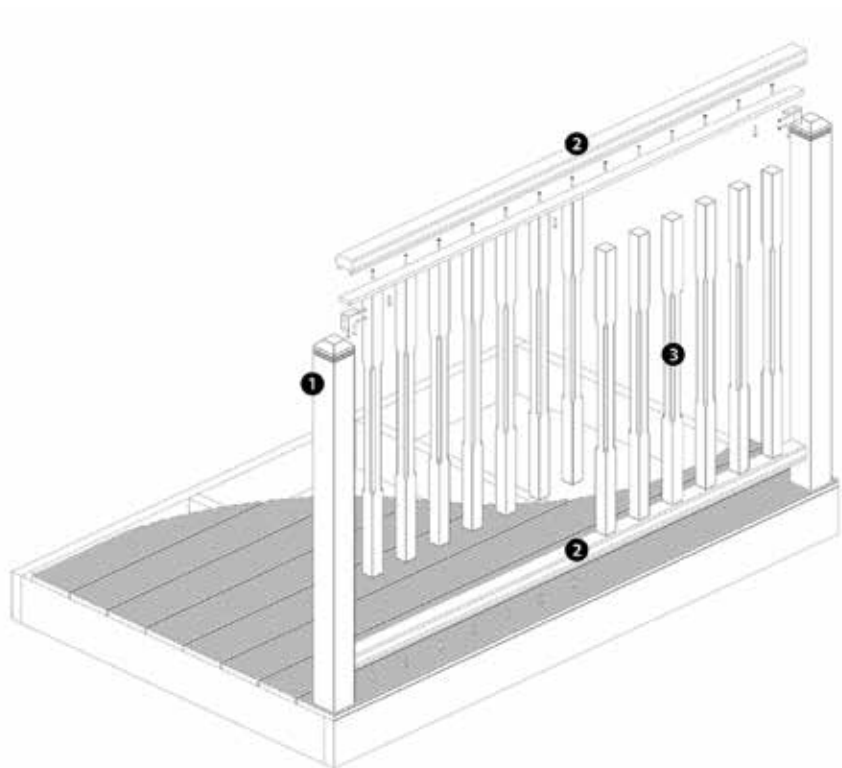

PRODUCT CODE	DESCRIPTION	SIZES	TIMBER	PK QTY
❶ DEP12CB/15CB/24CB	Chamfered & beaded newel	1250/1500/2400	Treated pine	1
❷ DHU1.8/2.4	Universal rail	1795/2395	Treated pine	1
❸ DEDST9041P	Stop chamfered baluster	41	Treated pine	1



CORE DEK

STOP CHAMFERED RED HARDWOOD/

Stop chamfered is the perfect design for red hardwood.

Its simplicity lets us focus on the main attraction; one of nature's finest timbers and a species whose rightful place is the great outdoors.

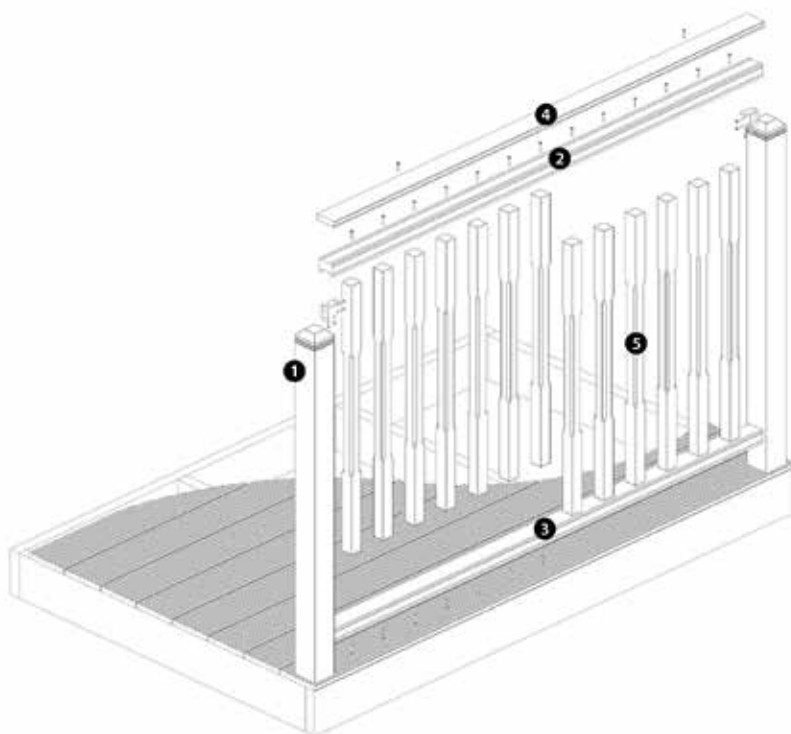

PRODUCT CODE	DESCRIPTION	SIZES	TIMBER	PK QTY
1 DEP15CBM	Chamfered & beaded newel	1495	Red hardwood	1
2 DHR1.2/1.8M	Hardwood Handrail	1195/1795	Red hardwood	1
3 DBR1.2/1.8M	Hardwood Baserail	1195/1795	Red hardwood	1
4 DCAP1.2/1.8M	Rail cap	1195/1795	Red hardwood	1
5 DEDST9041M	Stop chamfered spindle	41	Red hardwood	1



CORE DEK

TURNUED SOFTWOOD/

Seasons come and go but our turned decking range is a timeless classic. It's also one of our most flexible designs and works beautifully in gardens of all shapes and sizes.

Diagram & Table show double stack rail option.

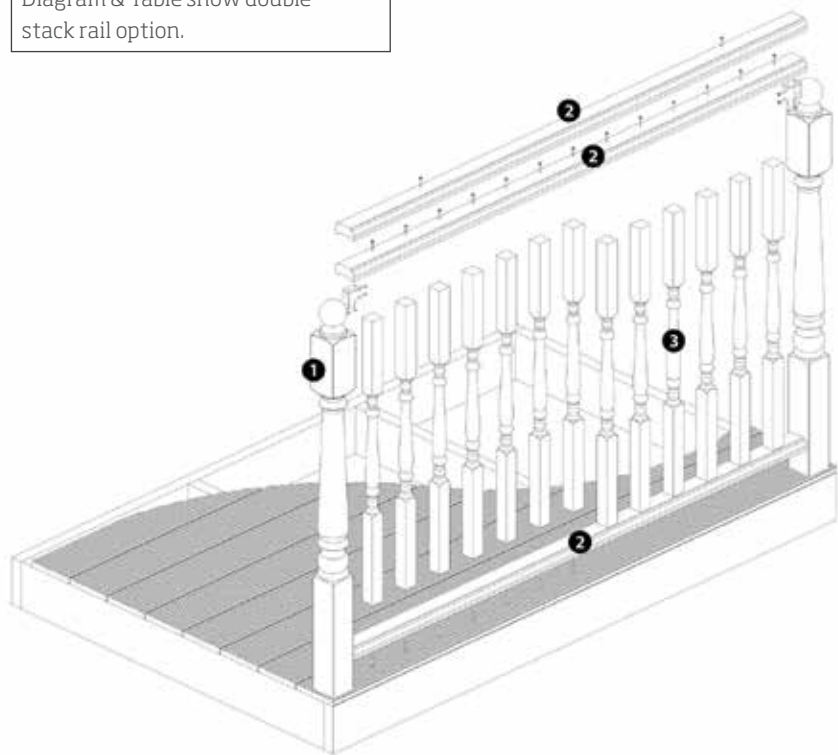

PRODUCT CODE	DESCRIPTION	SIZES	TIMBER	PK QTY
① DEP12CAP/15CAP	Turned newel	1250/1500	Treated pine	1
② DHNEW1.8/2.4	Double stack universal rail	1795/2395	Treated pine	1
③ DED90	Turned spindle	41	Treated pine	1

• Alternative rails as show in photograph Quote Code DHU1.8 / 2.4



CORE DEK

TURNED RED HARDWOOD/

Stunning is the only way to describe the red hardwood version of our traditional turned Core Dek range.

The colour. The feel. There's no better deck.

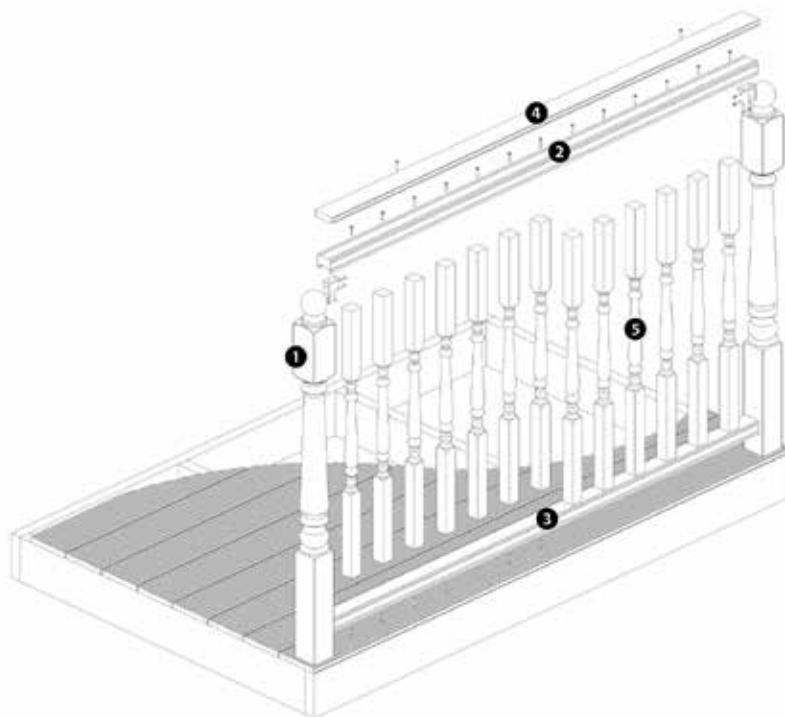

PRODUCT CODE	DESCRIPTION	SIZES	TIMBER	PK QTY
1 DEP15CAPM	Turned newel post	1495	Red hardwood	1
2 DHR1.2/1.8M	Handrail	1195/1795	Red hardwood	1
3 DBR1.2/1.8M	Baserail	1195/1795	Red hardwood	1
4 DCAP1.2/1.8M	Handrail cap	1195/1795	Red hardwood	1
5 DED90M	Turned spindle	41	Red hardwood	1



CORE DEK

AMERICAN SOFTWOOD/

There's no doubt the design of our American range is engrained with its colonial heritage, but by adding our flat-top capping rail we've made these decks more practical and a great place to while away the hours.

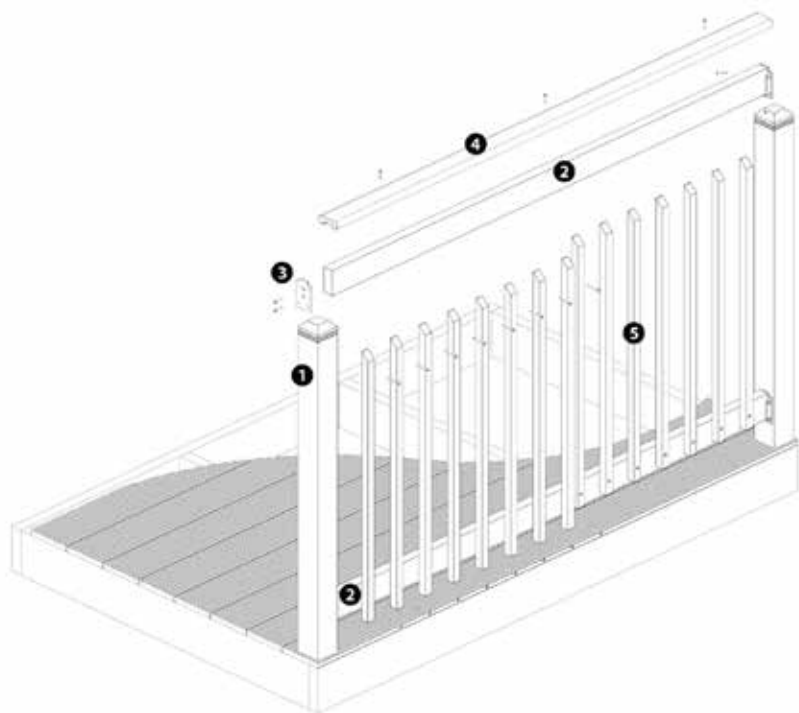

PRODUCT CODE	DESCRIPTION	SIZES	TIMBER	PK QTY
① DEP12CB/15CB/24CB	Chamfered & beaded newel	1250/1500/2400	Treated pine	1
② DCMR	Pine rail	1795	Treated pine	1
③ DCVRB	Rail fixing brackets	N/A	ABS	2
④ DCAP18	Capping rail	1795	Treated pine	1
⑤ DECAM	American baluster	27	Treated pine	1



For further information or assistance on
our extensive range of decking accessories,
contact our friendly customer service team
freephone: **0800 085 3475**
email: **enquiries@cheshiremouldings.co.uk**
visit us at: **www.cheshiremouldings.co.uk**

CORE DEK

SQUARE SOFTWOOD/

For those that like to keep it simple, our square blanks are just perfect. They're also made from the same great quality pine as the rest of our decking range so there's no sacrificing quality even if the function's more important than the form.

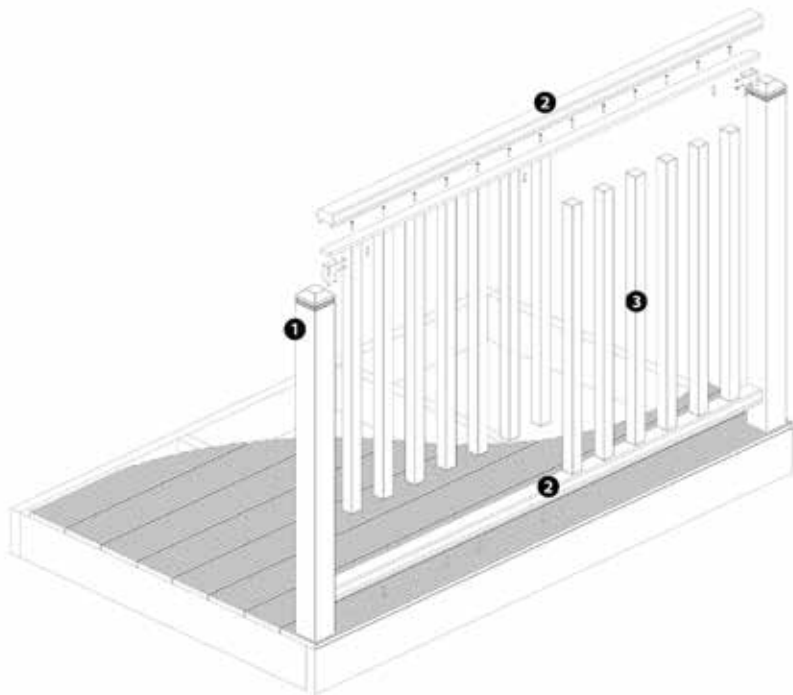

PRODUCT CODE	DESCRIPTION	SIZES	TIMBER	PK QTY
1 DEP12CB/15CB/24CB	Chamfered & beaded newel	1250/1500/2400	Treated pine	1
2 DHU1.8/2.4	Universal decking rail	1795/2395	Treated pine	1
3 41PBTR	Treated deck blank	41	Treated pine	1



STOP CHAMFERED SOFTWOOD/

axxys® DEK is a contemporary range of decking products designed to inspire.

A modular system of pine timbers with metal and ABS components, axxys® DEK removes the rigid boundary between your indoor and outdoor spaces to create a complete living environment.

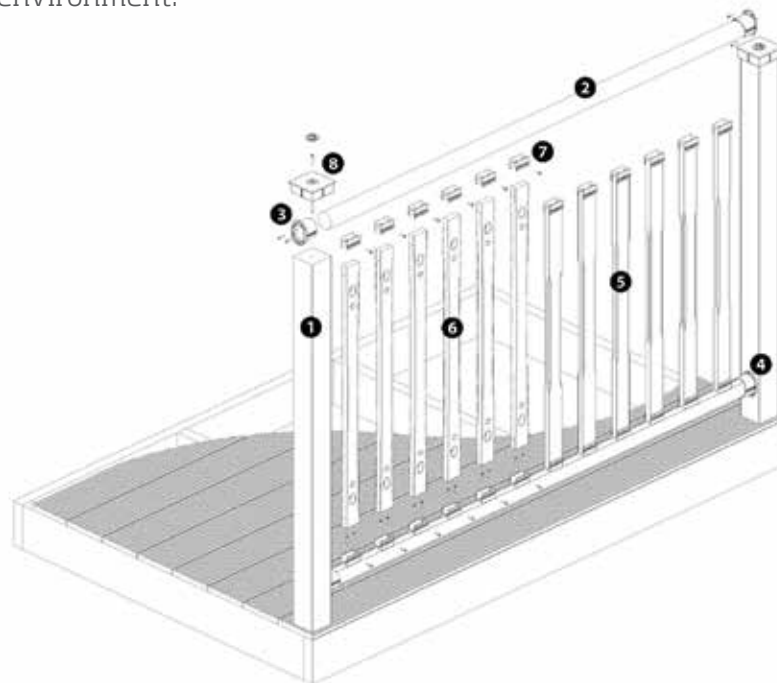

PRODUCT CODE	DESCRIPTION	SIZES	TIMBER	PKQTY
1 ADNP13/ADNP15	axxys® DEK Square newel post	1295/1495	Treated pine	1
2 ADRAIL1.8	axxys® DEK Universal rail	1795	Treated pine	1
3 ADUNICONA	axxys® DEK Handrail/Baserail connector	N/A	Zamac3	1 pair
4 ADUNICONA	axxys® DEK Handrail/Baserail connector	N/A	Zamac3	1 pair
5 ADSTB	axxys® DEK Stop chamfered	N/A	Treated pine	1
6 ADFTB	axxys® DEK Fretted baluster	N/A	Treated pine	1
7 ADTBA	axxys® DEK Baluster brackets	N/A	ABS	1 pair
8 ADCAPA	axxys® DEK Newel cap	N/A	ABS	1



STOP CHAMFERED RED HARDWOOD/

We didn't think it was possible to make **axxys® DEK** any better. Until we launched our red hardwood version that is!

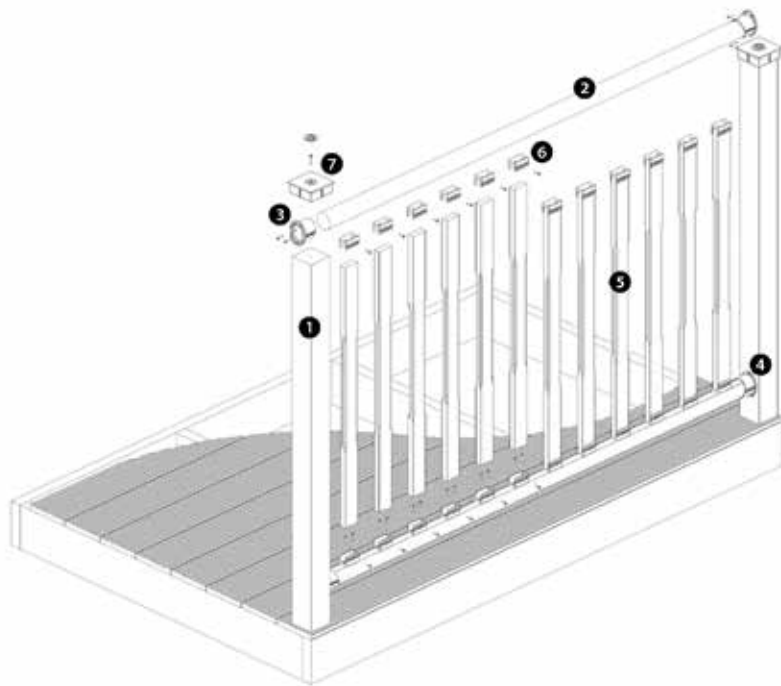

PRODUCT CODE	DESCRIPTION	SIZES	TIMBER	PK QTY
❶ ADNP15M	axxys® DEK Square newel post	1495	Red hardwood	1
❷ ADRAIL1.8M	axxys® DEK Universal rail	1795	Red hardwood	1
❸ ADUNICONA	axxys® DEK Handrail/Baserail connector	N/A	Zamac3	1 Pair
❹ ADUNICONA	axxys® DEK Handrail/Baserail connector	N/A	Zamac3	1 Pair
❺ ADSTBM	axxys® DEK Stop chamfered baluster	N/A	Red hardwood	1
❻ ADTBA	axxys® DEK Baluster brackets	N/A	ABS	1 Pair
❼ ADCAPA	axxys® DEK Newel cap	N/A	ABS	1



FRETTED SOFTWOOD/

Use the easy to install **axxys® DEK** to create a brand new decking feature from the ground up or to add modern touches to an existing deck platforms.

Engineered to last, **axxys® DEK** is the contemporary choice for all seasons.

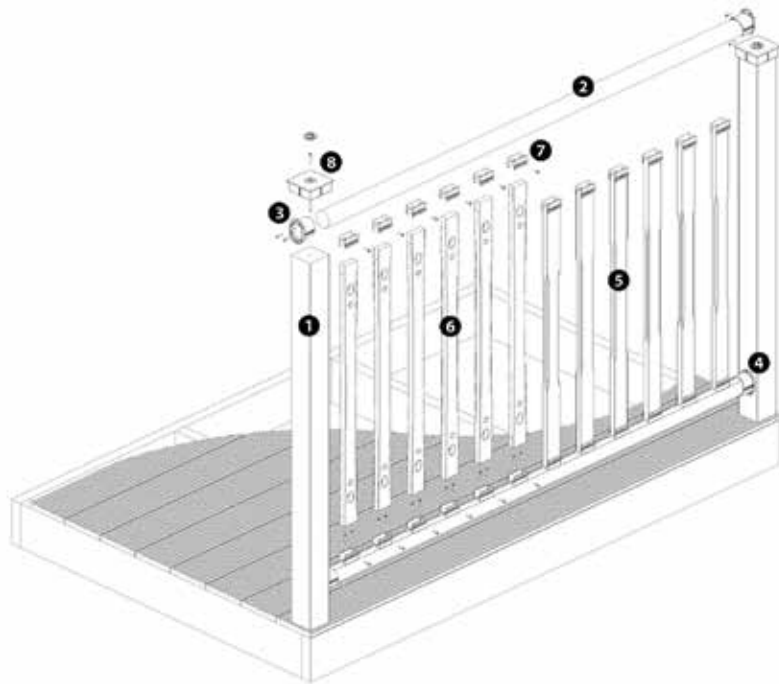

PRODUCT CODE	DESCRIPTION	SIZES	TIMBER	PKQTY
❶ ADNP13/ADNP15	axxys® DEK Square newel post	1295/1495	Treated pine	1
❷ ADRAIL1.8	axxys® DEK Universal rail	1795	Treated pine	1
❸ ADUNICONA	axxys® DEK Handrail/Baserail connector	N/A	Zamac3	1 Pair
❹ ADUNICONA	axxys® DEK Handrail/Baserail connector	N/A	Zamac3	1 Pair
❺ ADSTB	axxys® DEK Stop chamfered	N/A	Treated pine	1
❻ ADFTB	axxys® DEK Fretted baluster	N/A	Treated pine	1
❼ ADTBA	axxys® DEK Baluster brackets	N/A	ABS	1 Pair
❽ ADCAPA	axxys® DEK Newel cap	N/A	ABS	1



METAL DEK

BOW & EDEN ALUMINIUM/

New for 2013 our Bow and Eden balusters are the perfect way to customise your decking project.

Their subtle curvatures give visual depth to your balustrade just as their jet-black finish adds another layer of texture to any garden.

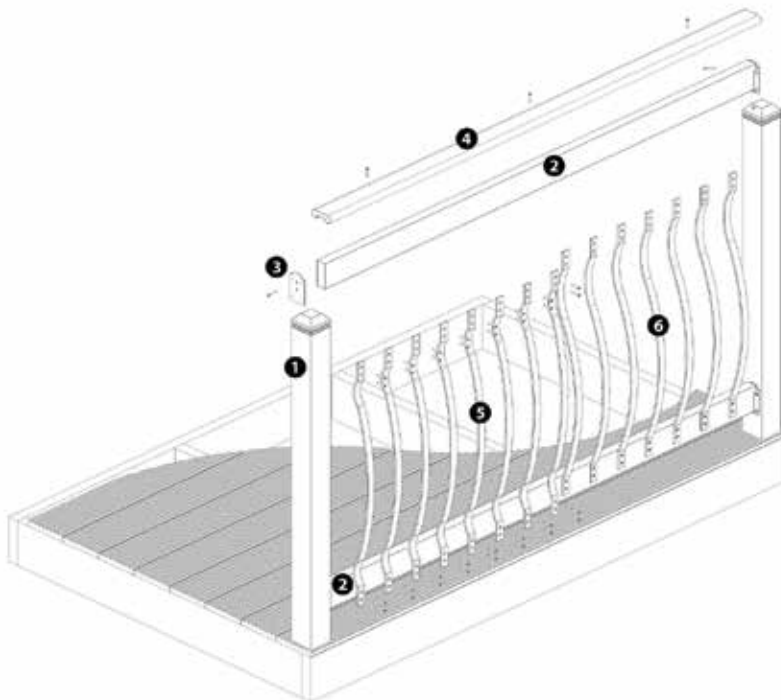

	PRODUCT CODE	DESCRIPTION	SIZES	TIMBER	PK QTY
1	DEP12CB/15CB/24CB	Chamfered & Beaded newel *	1250/1500/2400	Treated pine	1
2	DCMR	Metal baluster pine rail	1795	Treated pine	1
3	DCVRB	Rail fixing brackets	N/A	ABS	2
4	DCAP18	Capping rail	1795	Treated pine	1
5	DEK-BOW	Metal balusters	N/A	Black powder coated	5
6	DEK-EDEN	Metal balusters	N/A	Black powder coated	5

*Alternative wood newel posts available



Available in Thermowood® and Treated Softwood.

For more information, call our sales team on: **0800 085 3475**



CLEAR DEK

CLEAR SOFTWOOD/

Clear Softwood blends the organic warmth of quality timbers with stunning glass balusters for a deck that blends traditional and contemporary.

The result is a brilliant frame to nature's perfect backdrop.

Diagram and table show alternative newel with cap configuration

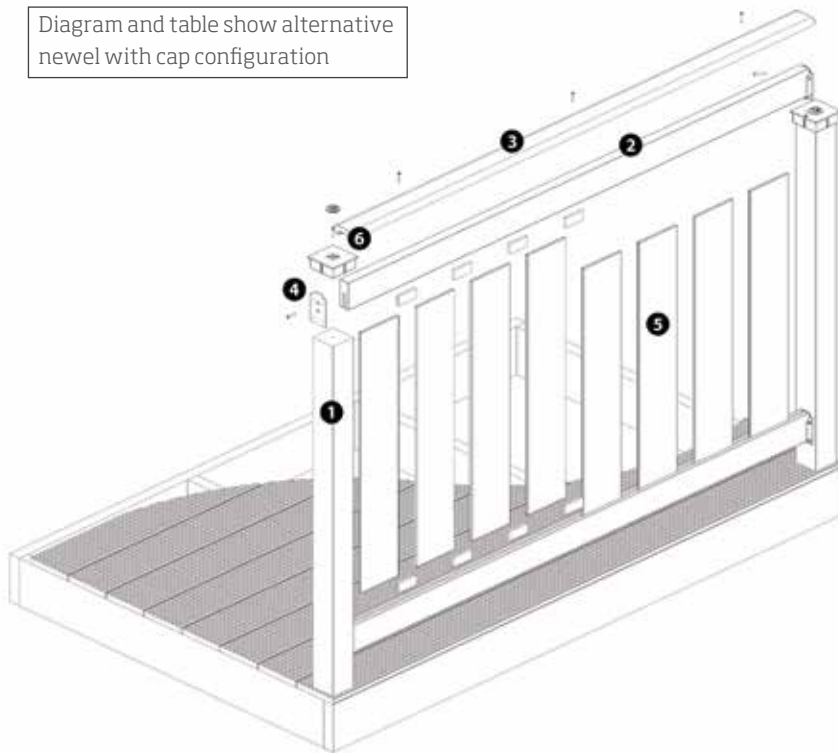

PRODUCT CODE	DESCRIPTION	SIZES	TIMBER	PKQTY
① ADNP13/ADNP15	Square newel post	1250/1500	Treated pine	1
② DCLRAIL	Clear rail	1795	Treated pine	1
③ DCAP18	Clear capping rail	1750	Treated pine	1
④ DCVRB	Clear rail fixing brackets	N/A	ABS	1 pair
⑤ DCLPAN	Clear panels	820	Toughened glass	7
⑥ ADCAPA	Newel cap	N/A	ABS	1

Available in Thermowood® and Treated Softwood.

For more information, call our sales team on: **0800 085 3475**



MODERN DEK/

This spring Cheshire Mouldings takes the contemporary look to a whole new level with the introduction of Modern DEK, our low maintenance aluminium extrusion balustrade system. This unique range boasts zinc brackets and a powder coated exterior for an ultra-modern, sleek finish that will perfectly enhance any refurbishment project. It's simplicity itself to install and can be combined with existing ranges for complete flexibility. For a modern look that is sure to be a timeless classic, Modern DEK offers something unique for a modern age.

For the latest news about the launch of this stunning range visit our website www.cheshiremouldings.co.uk

PRODUCT CODE	DESCRIPTION	SIZES	TIMBER	PKQTY
MTRB	Universal rail connectors	N/A	Zinc	1 pair
MTSR	Universal spindle rail	1800	Aluminium	1
MTGR	Universal glass panel	1800	Aluminium	1
MTPST	Aluminium deck post inc fixings and cap*	1200	Aluminium	1
DCLPAN	Clear panels	820	Toughened glass	7

*Alternative wood newel post available





DECKING COMPONENTS/
SOFTWOOD DECKING/
METAL & MODERN DEK/
HARDWOOD DECKING/
CLEAR & AXXYS DEK/
TIMBER TREATMENT/

SOFTWOOD DECKING/COMPONENTS

Timber /Finish	Product Code	Size	Pack Qty	RRP
----------------	--------------	------	----------	-----

HANDRAILS & BASERAILS

TREATED PINE	DHU18	1800 x 44 x 68	1	
TREATED PINE	DHU24	2400 x 44 x 68	1	
TREATED PINE	DHNEW1.8	1800 x 38 x 75	1	
TREATED PINE	DHNEW24	2400 x 38 x 75	1	

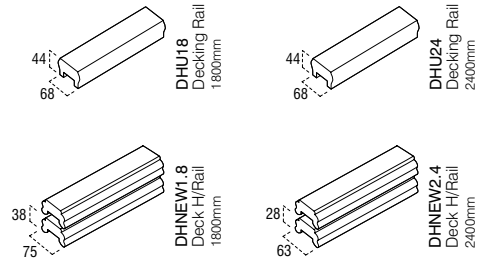

SPINDLES

TREATED PINE	41PBTR	895 x 41 x 41	1	
TREATED PINE	DED90	895 x 41 x 41	1	
TREATED PINE	DEDST9041P	895 x 41 x 41	1	

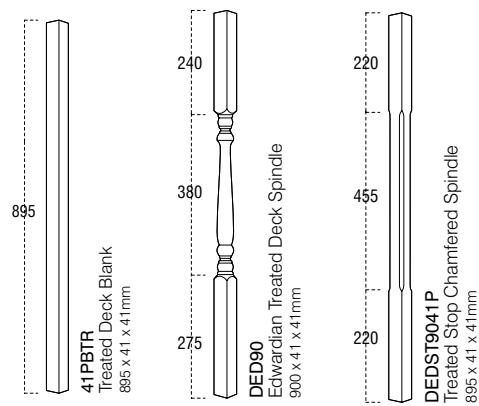

SOFTWOOD DECKING/COMPONENTS

Timber /Finish	Product Code	Size	Pack Qty	RRP
----------------	--------------	------	----------	-----

DECK POSTS

TREATED PINE	DEP12BLANK	1250 x 82 x 82	1
TREATED PINE	DEP12CAP	1250 x 82 x 82	1
TREATED PINE	DEP15CAP	1500 x 82 x 82	1
TREATED PINE	DEP12CB	1250 x 82 x 82	1
TREATED PINE	DEP15CB	1500 x 82 x 82	1
TREATED PINE	DEP24CB	2400 x 82 x 82	1
TREATED PINE	DEP12ST	1250 x 82 x 82	1
TREATED PINE	DEP15ST	1500 x 82 x 82	1

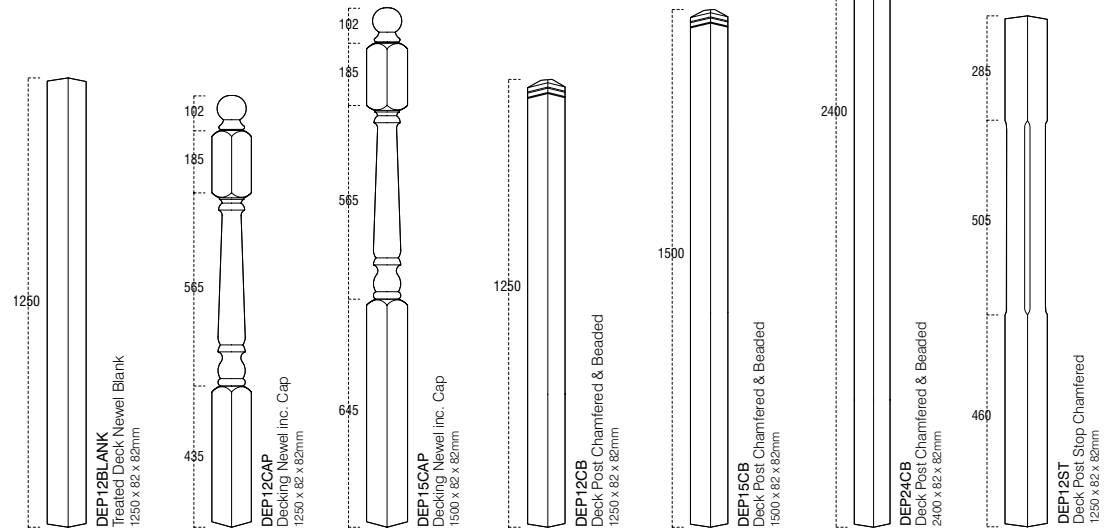

DECK PANELS

TREATED PINE	DESUN	1130 x 760 x 41	1
TREATED PINE	DEHAT	1135 x 760 x 32	1

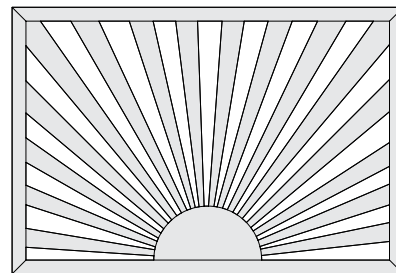

DESUN
Sunburst Decking Panel
1130 x 760 x 41mm

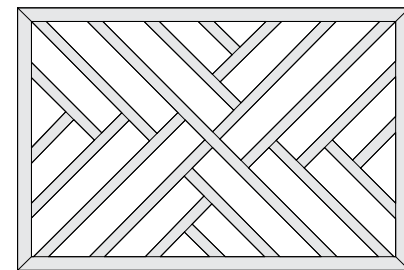

DEHAT
Cross Hatch Decking Panel
1135 x 760 x 32mm

SOFTWOOD DECKING/COMPONENTS

Timber /Finish	Product Code	Size	Pack Qty	RRP
----------------	--------------	------	----------	-----

AMERICAN RANGE

TREATED PINE	DCMR	1795 x 85 x 35	1	
TREATED PINE	DECAM	895 x 27 x 27	1	

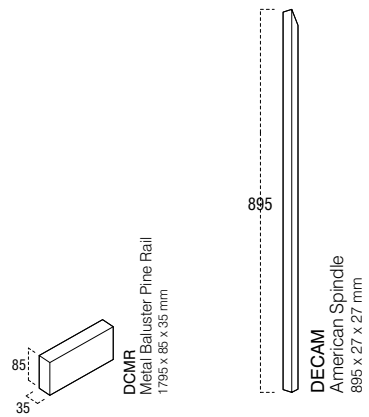

CAPS

TREATED PINE	DEB	132 x 85 x 85	1	
TREATED PINE	DEAC	132 x 84 x 84	1	
TREATED PINE	DEPTC	27 x 115 x 115	1	

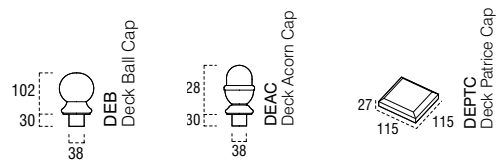

TREAD STRINGS

TREATED PINE	DS3	245 x 868 x 45	1	
TREATED PINE	DS5	245 x 1447 x 45	1	

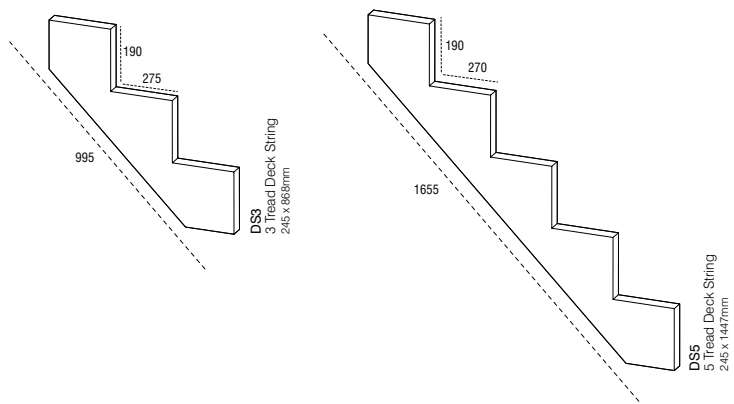

METAL & MODERN DEK/FIXINGS

Timber /Finish	Product Code	Size	Pack Qty	RRP
----------------	--------------	------	----------	-----

FIXINGS

ZINC STEEL	DSCREW100	100mm	50
ZINC STEEL	DSCREW150	150mm	50
ZINC STEEL	DSCREW40	40mm	150
ZINC STEEL	DSCREW50	50mm	200
ZINC STEEL	DSCREW63	60mm	200
ZINC STEEL	DSCREW75	75mm	200
ZINC STEEL	DECKIT	N/A	1pr



BOW & EDEN FIXINGS/

ALUMINIUM	DEK-EDEN	820 x 26 x 6	5
ALUMINIUM	DEK-BOW	820 x 26 x 6	5
TREATED PINE	DCMR	1795 x 35 x 85	1
ABS	DCVRB	N/A	1pr

ALUMINIUM IS BLACK POWDER COATED

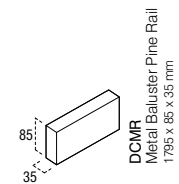
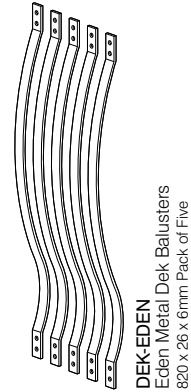
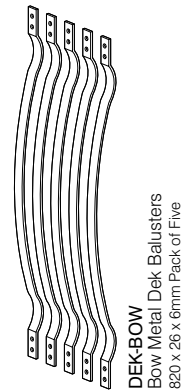

MODERN DEK

ZINC	MTRB	N/A	1
ALUMINIUM	MTSR	1800 x 60 x 55	1
GLASS	MTGR	1800 X 60 X 55	1
ALUMINIUM	MTPST	1200 x 82 x 82	1

HARDWOOD DECKING/COMPONENTS

Timber /Finish Product Code Size Pack Qty RRP

HANDRAILS, BASERAILS & CAPPING RAILS

RED HARDWOOD	DHR1.8M	1800 x 58 x 44	1
RED HARDWOOD	DHR1.2M	1200 x 58 x 44	1
RED HARDWOOD	DBR1.8M	1800 x 58 x 44	1
RED HARDWOOD	DBR1.2M	1200 x 58 x 44	1
RED HARDWOOD	DCAP18M	1800 x 71 x 20	1
RED HARDWOOD	DCAP12M	1200 x 71 x 20	1

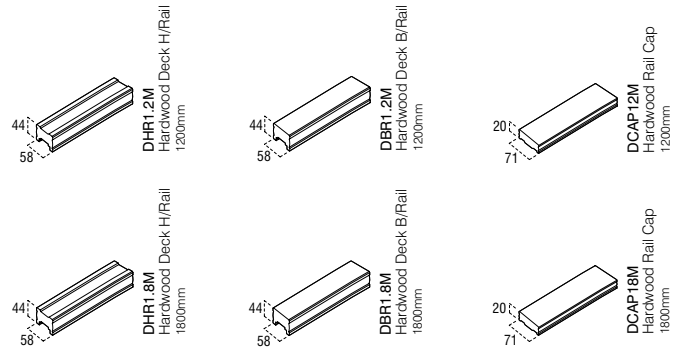

SPINDLES

RED HARDWOOD	DED90M	895 x 41 x 41	1
RED HARDWOOD	DED110M	1100 x 41 x 41	1
RED HARDWOOD	41PBTRM	895 x 41 x 41	1
RED HARDWOOD	41PBTR110M	1100 x 41 x 41	1
RED HARDWOOD	DEDST9041M	895 x 41 x 41	1
RED HARDWOOD	DEDST11041M	1100 x 41 x 41	1

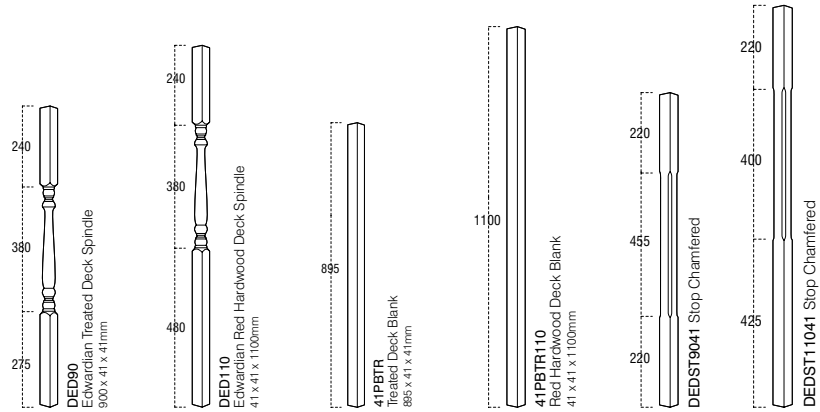

NEWELS

RED HARDWOOD	DEP15CAPM	1500 x 91 x 91	1
RED HARDWOOD	DEP15CBM	1500 x 91 x 91	1

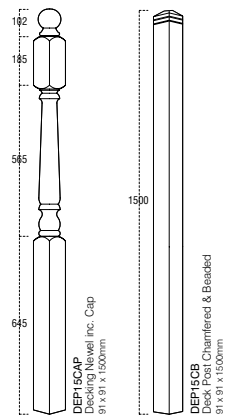

CLEAR & axxys® DEK/COMPONENTS

Timber /Finish	Product Code	Size	Pack Qty	RRP
CLEAR DEK				
TREATED PINE	DCLRAIL	1795 x 28 x 85	1	
TREATED PINE	DCAP18	1795 x 80 x 26	1	
ABS	DCVRB	N/A	1pr	
GLASS	DCLPAN	8 x 150 x 820	7	

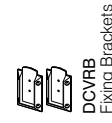
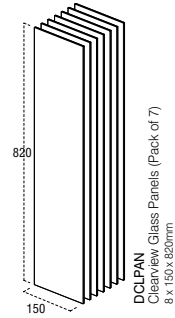
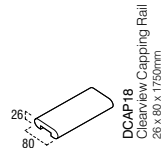
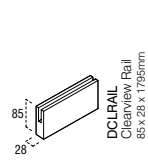

AXXYS DEK

TREATED PINE	ADRAIL1.8	1795 x 54 x 54	1	
RED HARDWOOD	ADRAIL1.8M	1795 x 54 x 54	1	
TREATED PINE	ADNP13	81 x 81 x 1250	1	
TREATED PINE	ADNP15	81 x 81 x 1500	1	
RED HARDWOOD	ADNP15M	81 x 81 x 1500	1	
TREATED PINE	ADSTB	55 x 21 x 887	1	
RED HARDWOOD	ADSTBM	55 x 21 x 887	1	
TREATED PINE	ADFTB	55 x 21 x 887	1	
ALUMINIUM	ADCAPA	100 x 100 x 35	1	
BLACK	ADCAPB	100 x 100 x 35	1	
ALUMINIUM	ADUNICONA	N/A	1pr	
BLACK	ADUNICONB	N/A	1pr	
ALUMINIUM	ADHRCONRKA	N/A	1pr	
ALUMINIUM	ADTBA	N/A	1pr	
ALUMINIUM	ADTBAB	N/A	10prs	
ALUMINIUM	ADTBRKA	N/A	1pr	
BLACK	ADTB	N/A	1pr	
BLACK	ADTB	N/A	10prs	

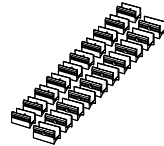
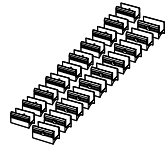
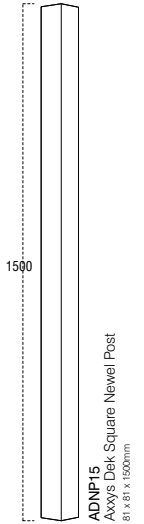
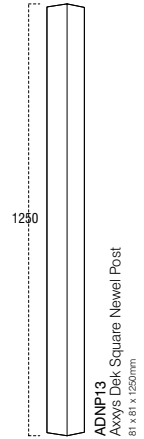
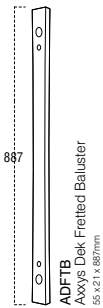
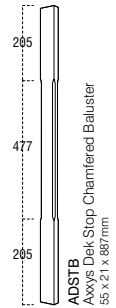
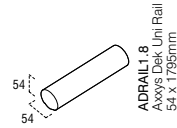

*NOTE FOR STOCKISTS - AXXYS DEK COMPONENTS MUST BE STORED UNDER COVER

TIMBER TREATMENT/

THE VERY BEST PROTECTION FOR YOUR DECKING TIMBERS/

The full range of softwood used for our decking products have been pressure treated within our own facilities with TANALITH E wood preservative. This latest generation, environmentally advanced formulation treatment provides a proven and superior long-term protection that will give you real confidence for your decking project. The resulting TANALISED E treated components are fully protected against all forms of wood decay and insect attack, giving a typical service life of 15 years and beyond.

The treated timber is initially pale green colouration, slowly weathering to a honey brown and to a silver grey. TANALISED E pressure treated timber does not need to be painted or stained to maintain the preservative protection, although a decorative coating can be added if desired.

WHAT IS TANALITH E?

TANALITH E is a unique, highly effective preservation protection system based on patented copper Triazole technology, developed by Arch, world leaders in timber protection technology. The copper is derived from recycled sources and is well known for its fungicidal and insecticidal properties. Combining copper with a dual triazole system broadens its spectrum of activity to give complete protection against all wood decay organisms. The triazoles used in TANALITH E are biodegradable and are commonly used to protect many of the food crops we eat.

PROVEN PERFORMANCE

TANALITH E wood preservative has now been used successfully in the UK for over 12 years and is the premium wood preservative in more than 35 countries worldwide. Not only does it meet the requirements of the industry standard BS8417, but its performance credentials exceed other world preservatives on the market. TANALITH E has been tested in more than 20 independent field sites around the world under a variety of conditions.

Our preservative treatments are strictly controlled by our own fully trained plant operators to ensure the correct level of protection for the timbers.

WORKING WITH TANALISED E PRESSURE TREATED TIMBER

With the preservative fully impregnated into the wood, TANALISED E pressure treated timber is a safe and versatile construction material. The normal precautions that would be used with untreated timber should be employed - a detailed consumer information leaflet is available on request.

If any cutting, notching or drilling is made to the treated timber components, any exposed surfaces must be liberally swabbed with ENSELE end grain preservative to maintain the integrity of the treatment. ENSELE end grain preservative is available through Cheshire Mouldings.



THE TREATMENT PROCESS

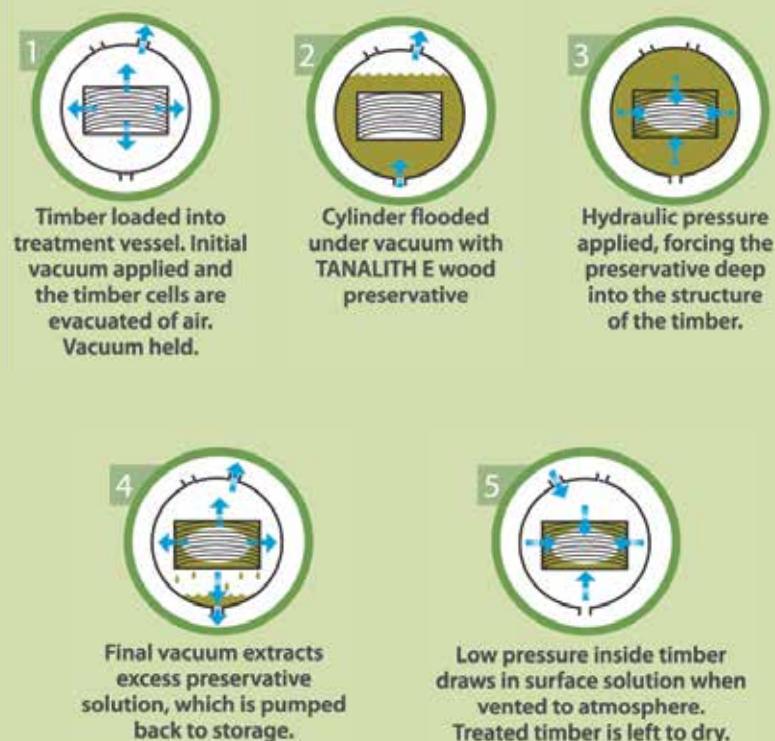

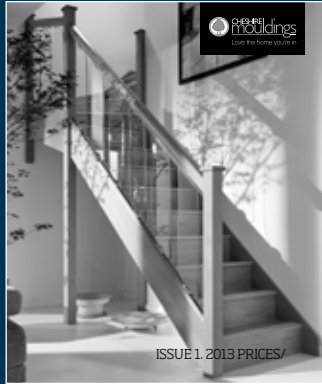

PRICE LIST



FLOORING BROCHURE



MOULDINGS BOOKLET



Love the home you're in

Cheshire Mouldings & Woodturnings Ltd
Unit 7, Normans Road, Sutton, St. Helens WA9 4JQ
Telephone +44 (0)1744 811 545 Fax +44 (0)1744 811 475
Email enquiries@cheshiremouldings.co.uk
www.cheshiremouldings.co.uk

For sales or technical help call 0800 085 3475

© 2013 Cheshire Moulding & Woodturnings Ltd.

